

HEALING COVE

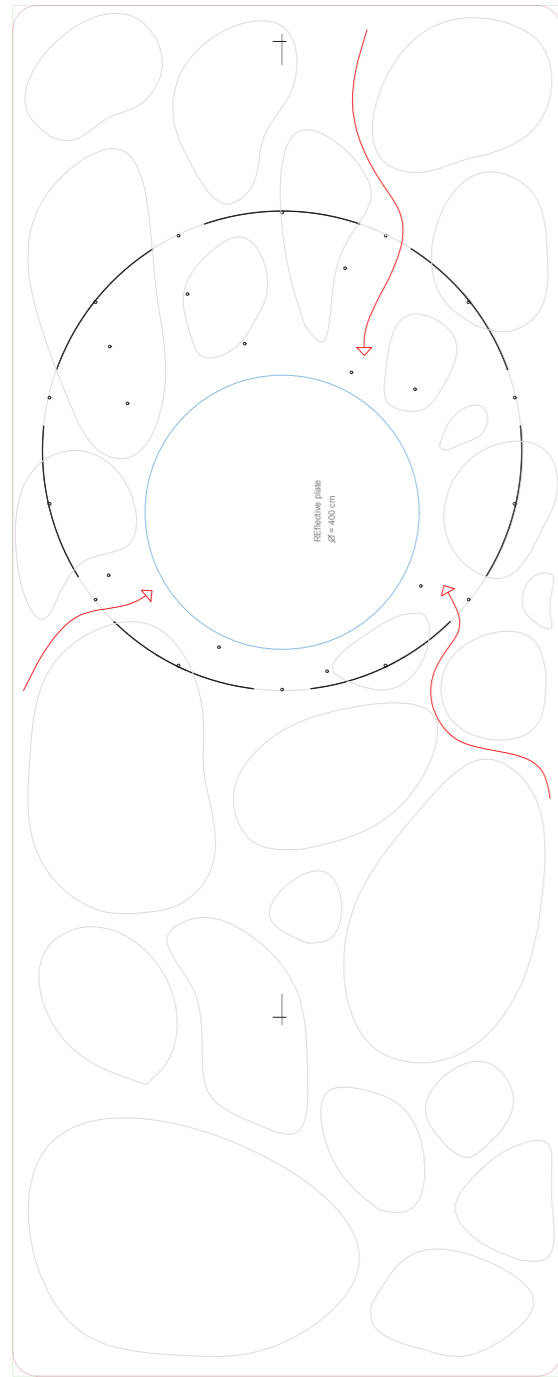

Circulation diagram
Ground plan

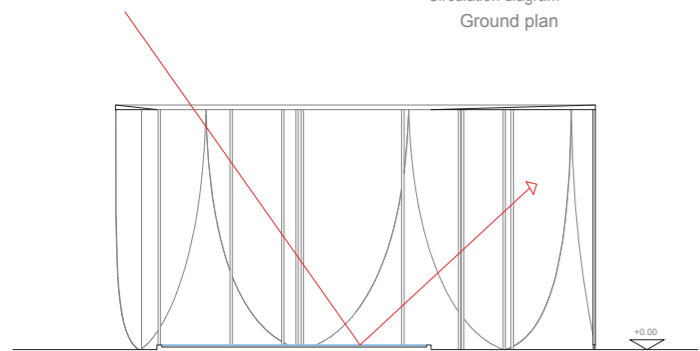

Direct sun light path / Reflective plate
Sec a'a

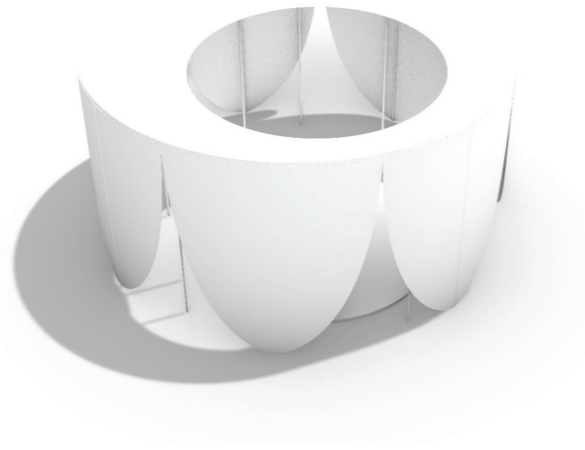

air - light - dream plants

As these plots of land are revisited by humans time and time again they remind us of more than its botanical or scientific inquires. These landscapes being far beyond their physical scope.

For J. A Baker a place can be defined by the natural light that shines through it - where one can find refuge, seclusion and healing.

concept

The garden consists of self seeding perennials, an open air pavillion and a reflective irrigation plate drawing ambient and direct sun light. Perennials are actually the most reliable plants there are - they are not only tough but also self seeding so they can increase almost forever! They can be trusted to come back the next season.

- Mc_ *Muhlenbergia capillaris* ○
- St_ *Stipa tenuissima* ○
- Ech_ *Echinops* ○
- D_ *Drimys* ○
- Yst_ *Yellow star thistle* ○
- Eg_ *Erigonome gracile* ○
- Is_ *Isatis tinctoria* ○

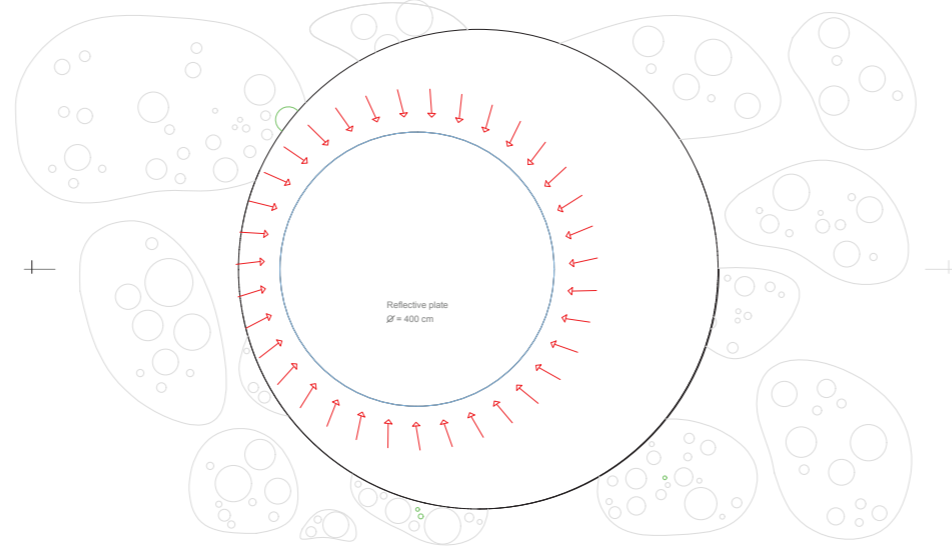

Roof irrigation system
Roof plan

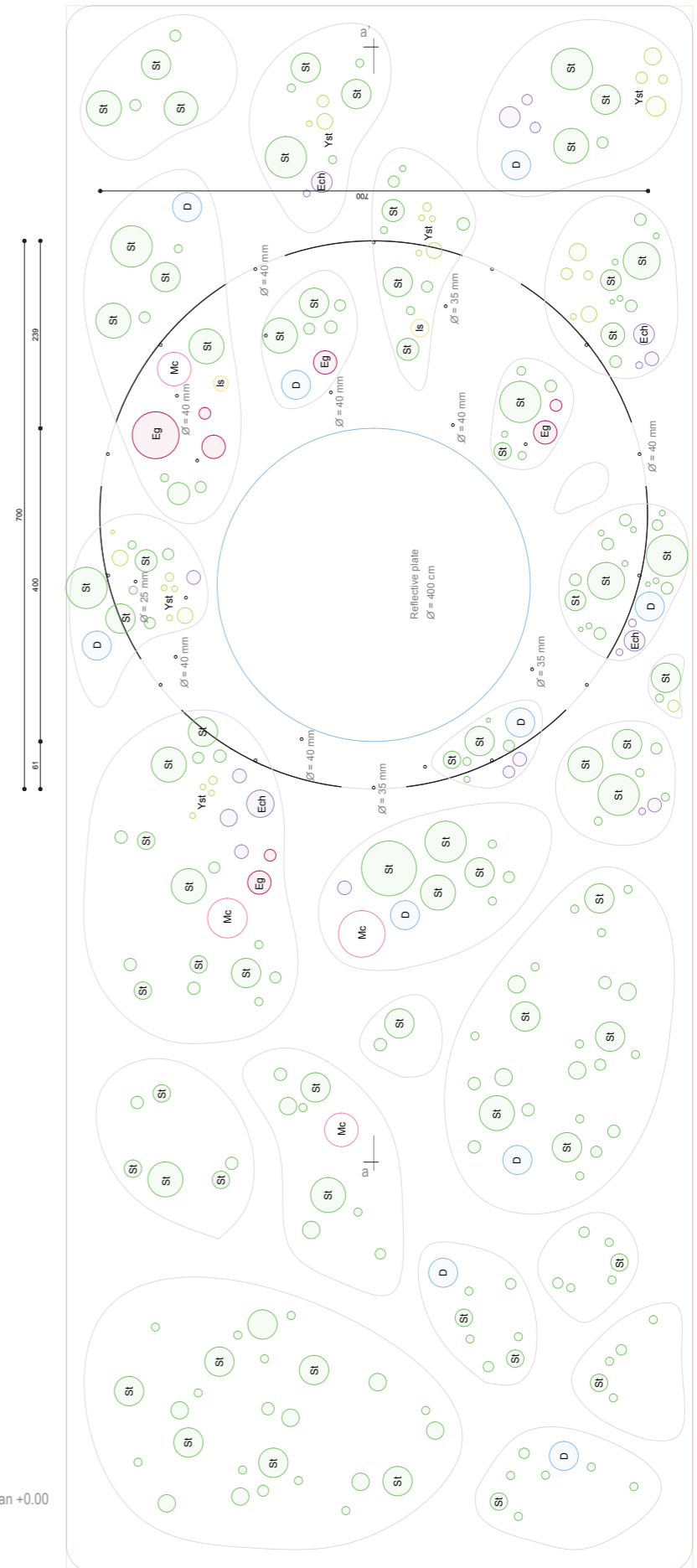

Ground plan +0.00

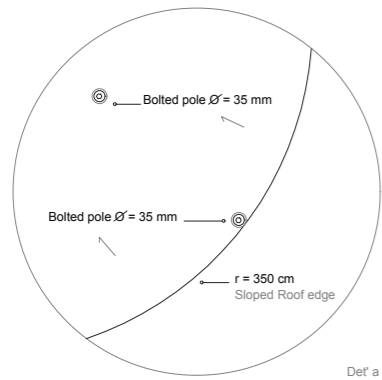

Det' a Roof plan

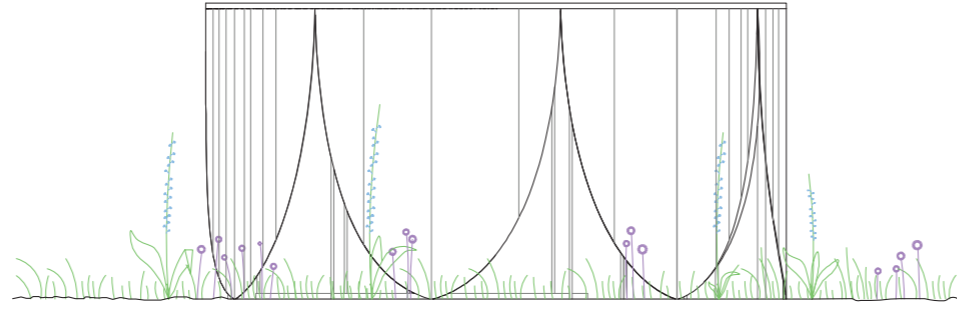

South Facade

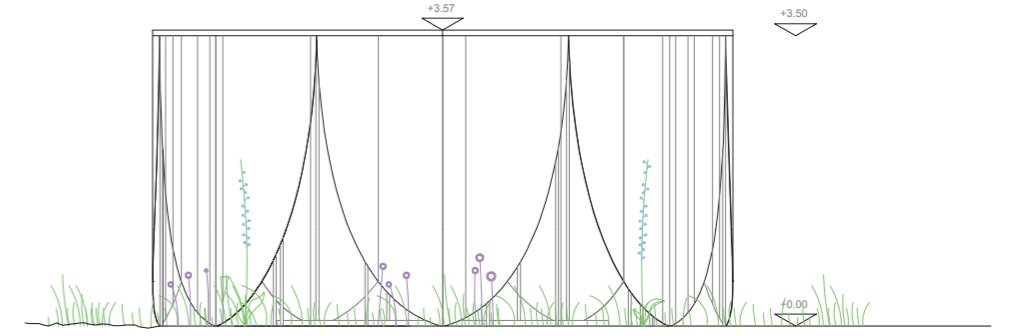

East Facade

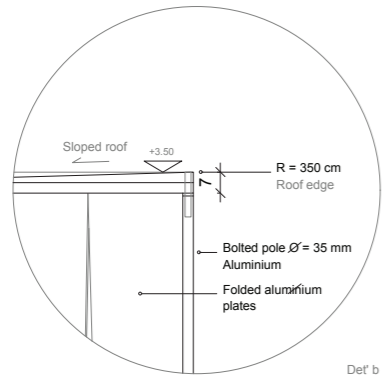

Det' b Sec' a'a

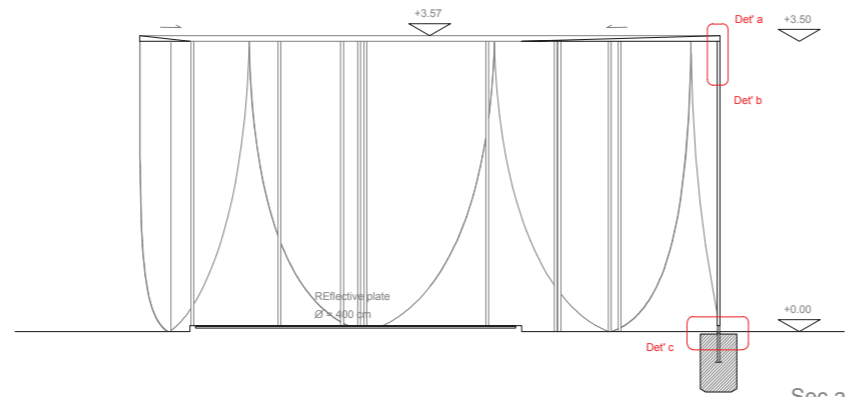

Sec a'a

'This is now a different place from what it was two hours ago. There is no mysterious essence we can call- place. Place is change. Motion preserved in the amber of memory.'

J. A Baker

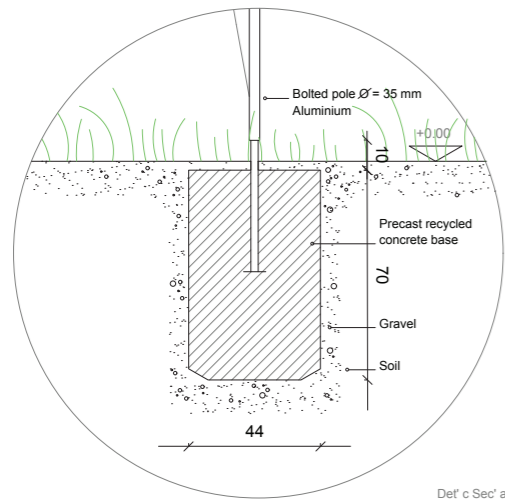

Det' c Sec' a'a

